

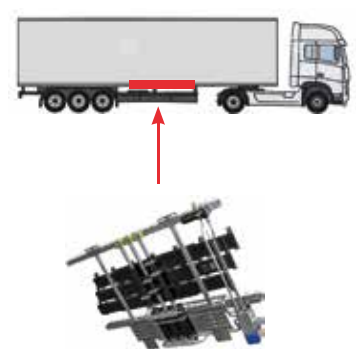

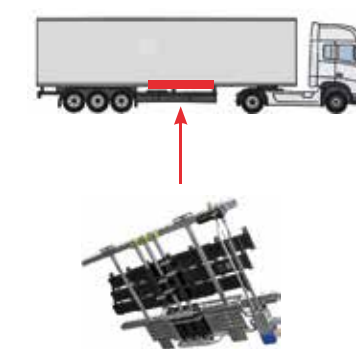

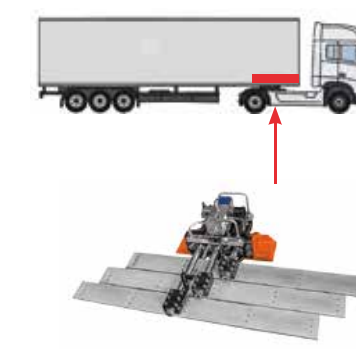



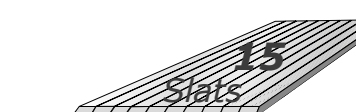

## Table of specification

«Semi leak proof»	«Leak resistant with tank»	«Leak proof»
		
Drive unit under floor	Drive unit under floor	Drive unit above floor
		
Low moisture content	Intermediate moisture content	High moisture content
		No tank
145 L tank	180 l safety tank	
<input checked="" type="checkbox"/> Manual doors <input checked="" type="checkbox"/> Hydraulic door	<input checked="" type="checkbox"/> <del>Manual doors</del> <del>Hydraulic door</del>	<input checked="" type="checkbox"/> <del>Manual doors</del> <del>Hydraulic door</del>
<input checked="" type="checkbox"/> 	<input type="checkbox"/> 	<input type="checkbox"/> 
		
No loss of volume	No loss of volume	Volume reduced by 5 m <sup>3</sup>
€	€€	€ € €



Our range of FMA®



«Side doors»



«General purpose»



Floor range designed for product with moisture content



«Sheeting range»



«Floor range»



P-N2-FMA-Floor-range-moisture-content-ENG / © Legras Industries 2020





FMA®

FLOOR RANGE DESIGNED FOR PRODUCT WITH MOISTURE CONTENT



The FMA® moving floor trailer specialist



Legras industries : 37, rue Marcel-Paul, CS20204, 51206 Epernay Cedex - France  
 Tel (+33) 3 26 53 32 10 - Fax (+33) 3 26 51 77 33 - Email : info@legras.fr  
 Legras industries is a member of CARCOCERCO     
[www.legras-industries.com](http://www.legras-industries.com)





# FMA® «Semi leak proof»

Low moisture content



# FMA® «Leak resistant with tank»

Intermediate moisture content



# FMA® «Leak proof»

High moisture content

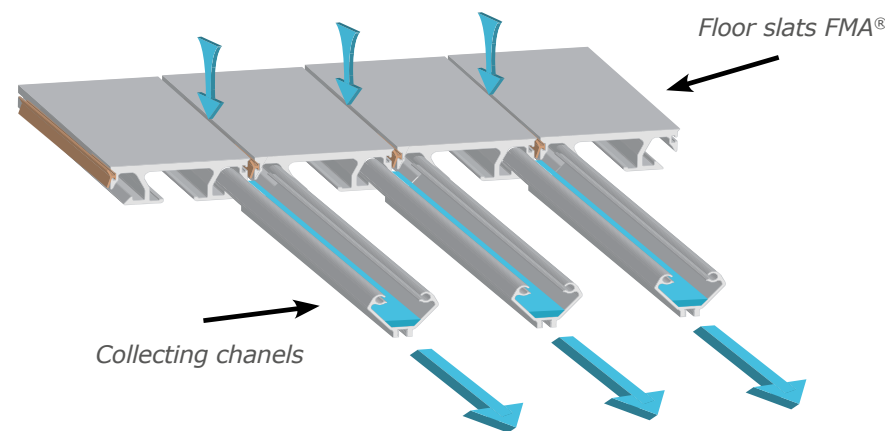
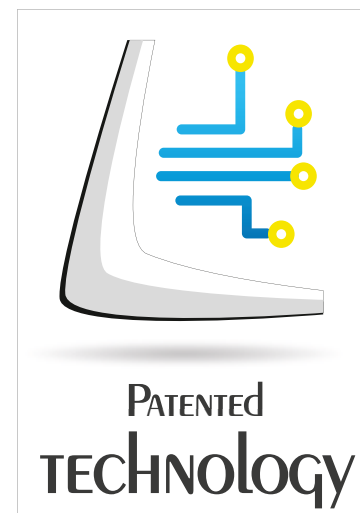

must be cleaned frequently



Access hatch for high pressure cleaning



145 liters tank or more

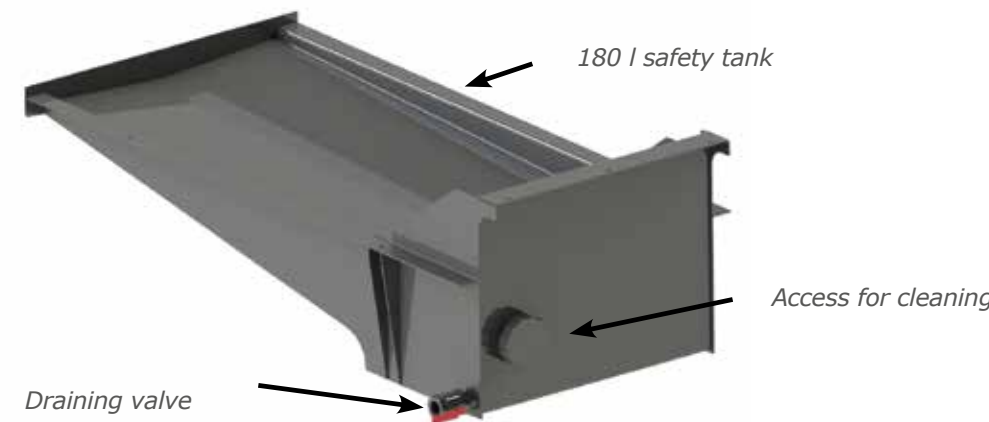

Moving floor suitable for household and food waste, liquids are contained in trailer



Leakproof hydraulic door, clamps and seals



180 l safety tank

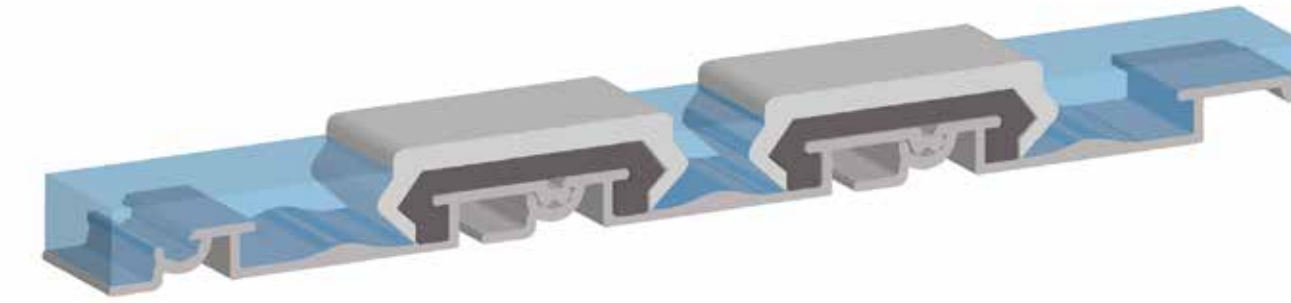

Moving floor suitable for household and food waste, liquids are contained in trailer



Leakproof hydraulic door, clamps and seals



Front mounted drive unit, access door for maintenance